



展林企業股份有限公司  
Fayin Enterprise Limited



Price  
Quality  
Technology  
Service

2025

價格 · 品質 · 技術 · 服務



English Version



展林企業股份有限公司  
FAYIN ENTERPRISE LIMITED

上海展和測控技術有限公司  
TENWA MEASUREMENT & CONTROL CO., LTD.

### Company Objectives

**Fayin Enterprise Limited** has been engaged in the agency importation of instrumentation and the design of automatic control systems for over 40 years. Over these four decades, the broader environment has undergone continuous change, and **Fayin** has consistently adapted its pace to keep up with progress. We have persistently undertaken internal reorganizations to align with external developments. Our extensive experience has provided us with a profound understanding of the vital role that technical expertise plays in the field of automatic control. We cherish the abundant, hands-on technical knowledge we have accumulated, and are committed to preserving, applying, and passing it on.

In the course of expanding our business, we have also deeply recognized that price is the foremost factor in our customers' considerations. Therefore, cost reduction has become a crucial objective. However, in our pursuit of lower costs, we have never forgotten that quality is our primary commitment to our clients. No matter how attractive the price, we will never compromise the standards by which we select products.

The foundation of **Fayin Enterprise Limited** lies in **Price, Quality, and Technical Expertise.**

### Company History

**Fayin Enterprise Limited** was founded in 1980. At its inception, the company focused on the Taiwanese market, serving as an agent for imported instrumentation. Internally, the organization was structured into three departments—Sales, Service, and Administration—each with clearly defined responsibilities, fostering a professional, conservative yet steady growth.

In 2002, the Service Department was renamed Technical Service Department. In 2011, in order to serve clients in southern and central Taiwan better, we established a branch office in Kaohsiung. Upholding over 30 years of dedication and reliability, we continue to serve our clients with a spirit of innovation and proactive service. •

### China Market Expansion

**Fayin** initiated its entry into the China market by opening a representative office in Beijing, marking the beginning of its presence on the mainland in 1984. Two years later, the company officially established a subsidiary. In 2019, The Shanghai entity was rebranded as **Shanghai Tenwa Measurement & Control Co., Ltd.**, signifying its commitment to offering comprehensive automatic control services rooted in strong technical foundations.





Matsushima Measure Tech Co., Ltd.

**Matsushima**  
Matsushima Measure Tech



- Radar Level Transmitter
- Powder Level Switch
- Powder Level Meter
- Dust Monitor
- Belt Tear Detector
- Position Detector
- Damper Actuator
- Speed Switch
- Position Switch
- Pull Cord Switch  
(Explosion-proof type available)
- Belt Sway Switch  
(Explosion-proof type available)



Application reference for Radar Level Transmitter

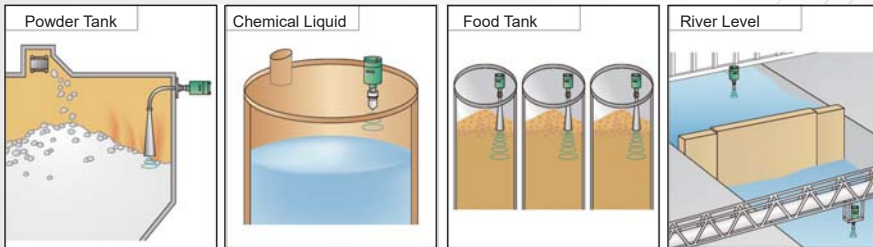

MG Co., Ltd.



- Signal Transmitter
- Angle Transmitter
- Electric Actuator
- Arrester
- PC Recorder
- Indicator
- Controller



- Temperature Transmitter
- Position Transmitter
- Remote I/O Module
- Data Acquisition System
- Power Converter
- Multifunction Power Meter

**MG**

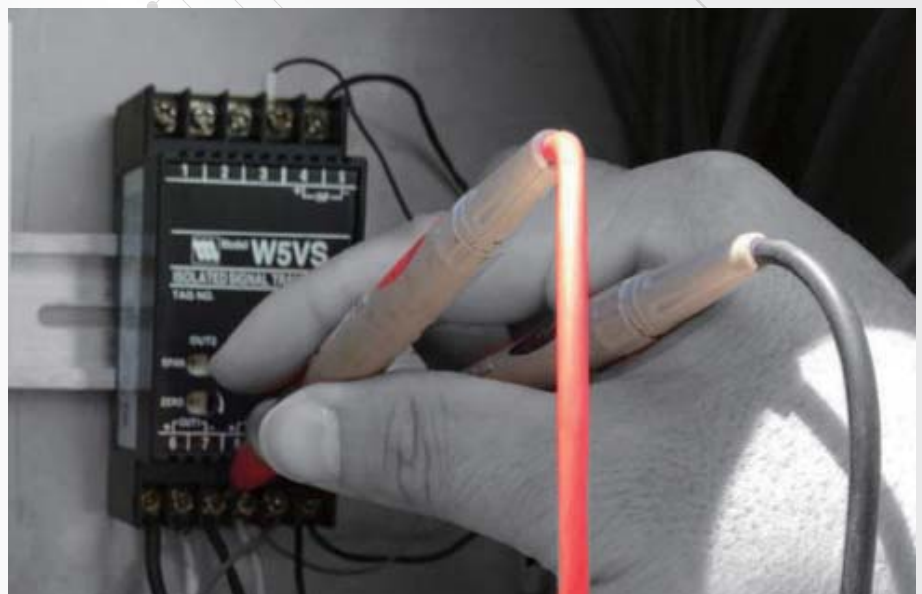

FUJI Electric Co., Ltd.

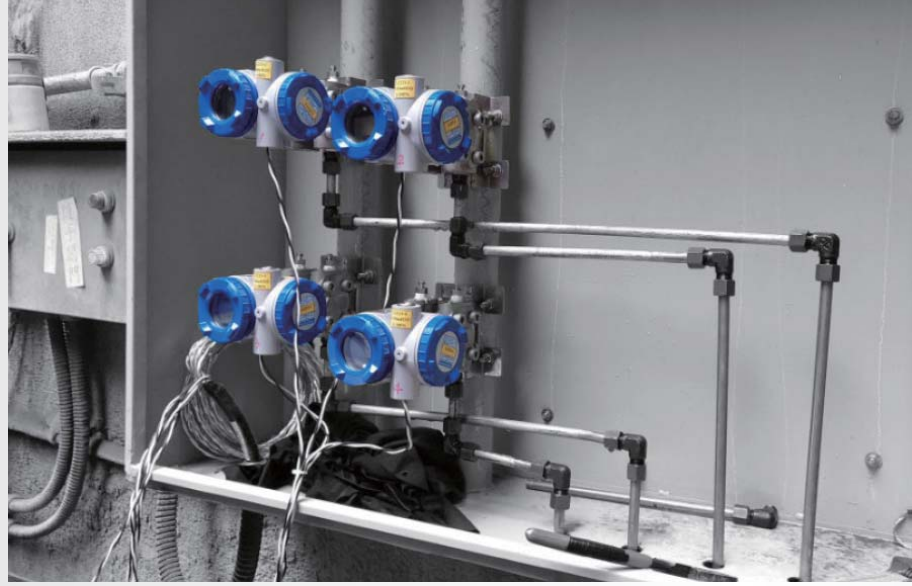

Pressure Transmitter  
Differential Pressure Trans.  
Diaphragm Level Trans.  
Controller



**FE 富士電機**  
e-Front runners



Ultrasonic Flow Meter  
Programmable Logic Controller (PLC)  
Human-Machine Interface (HMI)  
Gas Analyzer and Sampling System

TOWA Seiden Industrial Co., Ltd.



Rotary Paddle Level Switch  
Capacitance Level Switch  
Sounding Level Meter

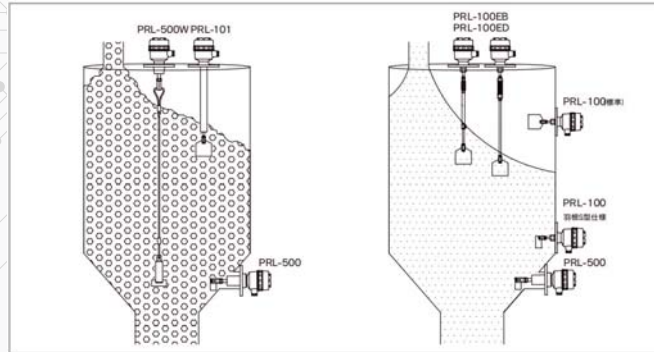

**TOWA SEIDEN**  
INDUSTRIAL CO., LTD.



電力の安全と  
持続可能社会をささえる

HAKARU PLUS CORPORATION



Hakaru+

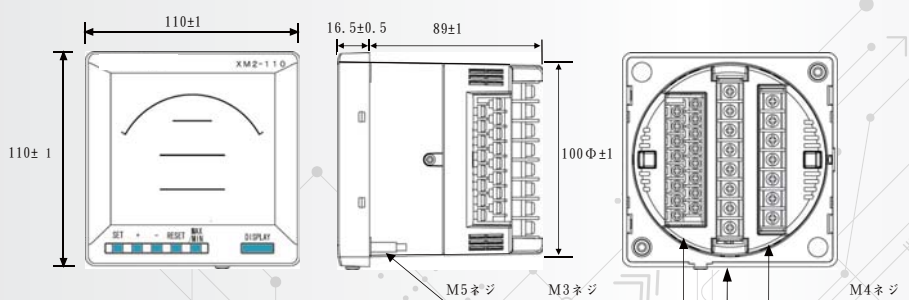

Power Converter  
Multifunction Power Meter  
Bar Graph Indicator  
Analog Indicator  
Digital Indicator

TSURUGA Electric Corporation



Analog Meter  
Digital Meter  
Measuring Instrument  
Tester

TSURUGA



Sankyo Pio-tech Co., Ltd.

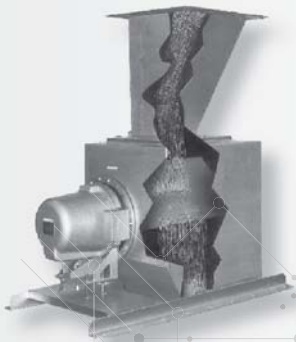

**sankyo**  
Piotech

- Power and Bulk Solids Flow Meter
- Millcom Automatic Controller for Grinding
- Feeder
- Micro Feeder

Nippon Valve Controls, Inc.



- Motorized Ball Valve
- Motorized Butterfly Valve
- Motorized Needle Valve
- Pneumatic Actuated Ball Valve
- Pneumatic Actuated Butterfly Valve
- Pneumatic Actuated Needle Valve



 Nippon Valve



ACI, Inc

- Power Converter
- Signal Converter
- Ultrasonic Level Meter
- Ultrasonic Flow Meter
- Temperature Monitoring System
- BTU Meter
- Vortex Flow Meter
- Pitot Tube Flow Meter
- Thermal Mass Flowmeter
- Micro Flowmeter



ProComSol, Ltd



iOS



Android

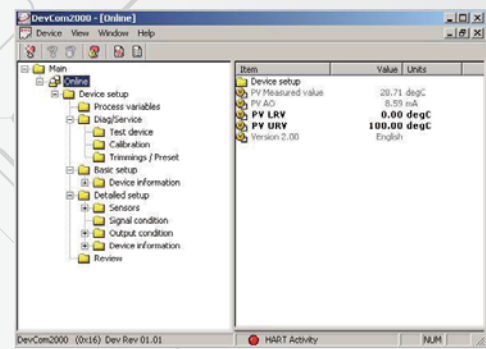

PC - Laptop



HART Instruments Communicator





Unimeasure, Inc.

Linear Position Transmitter  
Rotary Position Transmitter

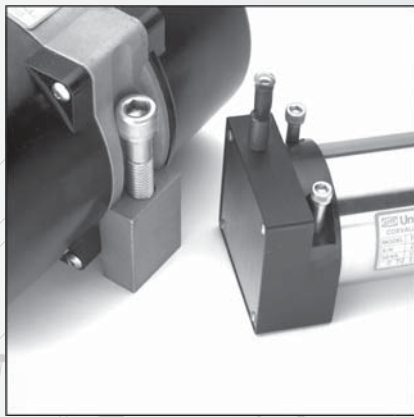
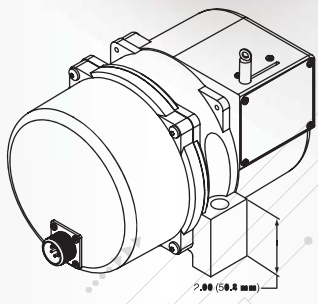
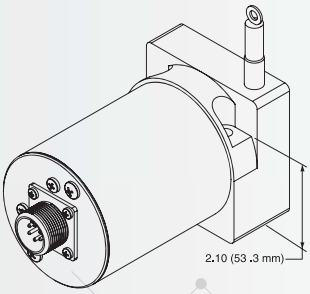

**um UniMeasure, Inc.**

McCrometer, Inc.

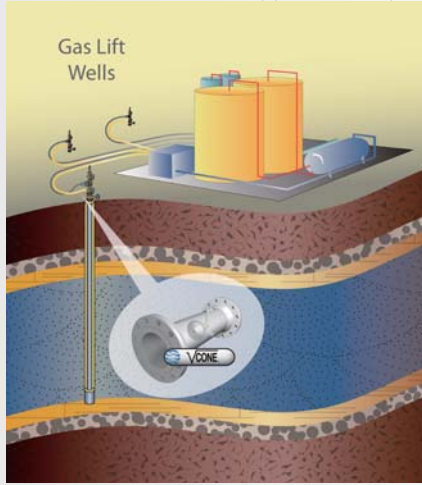

**McCROMETER**

- V-Cone Flow Meter
- Propeller Flowmeter
- Magnetic Flow Meter
- Insertion Type Magnetic Flow Meter





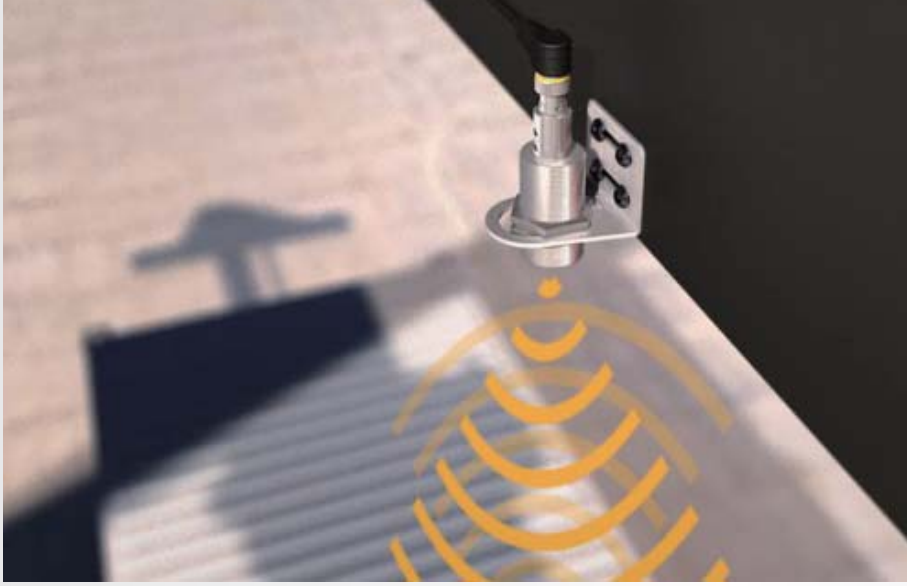

TURCK



Wiring System  
Controller Bus  
Tilt Sensor

Proximity Switch / Sensor / Transmitter  
Magnetic Inductive Linear Displacement Sensor

**TURCK**

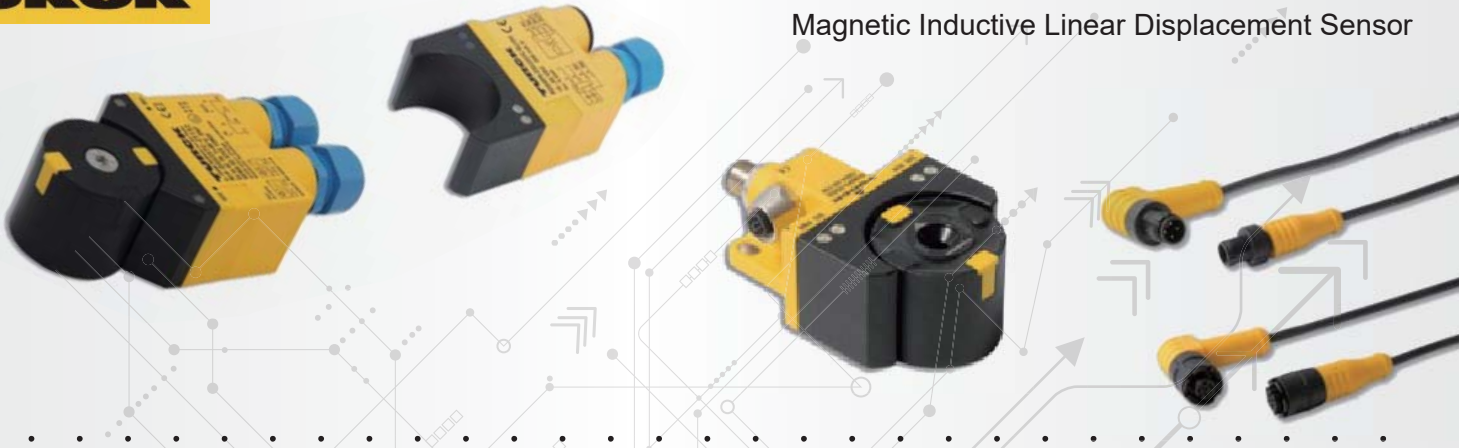

Hawk Measurement Systems

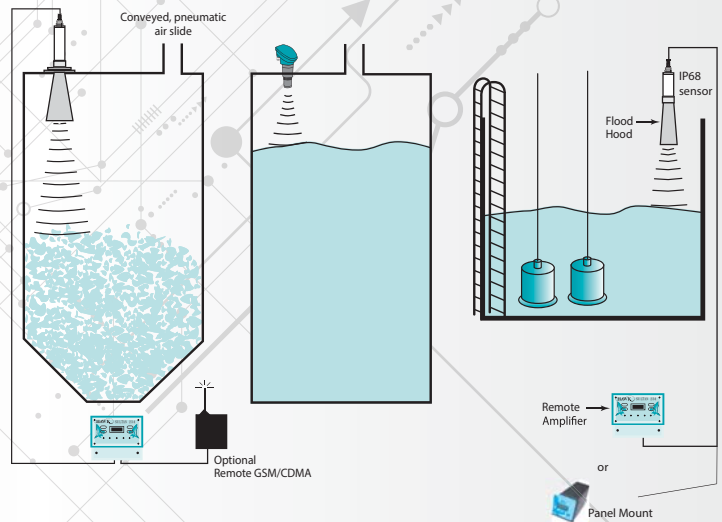

- Radar Level Meter
- Ultrasonic Level Meter
- Level Switch
- Open Channel Flow Meter
- Sonar Interface Level
- Guided Wave Radar Transmitters
- Admittance Level Switch





- Orifice Plate Flow Meter
- Variable Area Flow Meter
- Metal Tube Area Flow Meter
- Mass Flow Meter
- Propeller Flowmeter
- Pressure Gauge
- Pressure Transmitter
- Submersible Level Meter

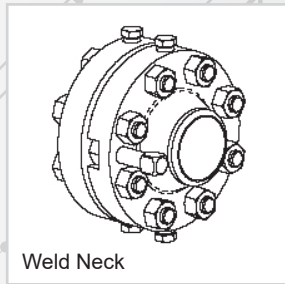
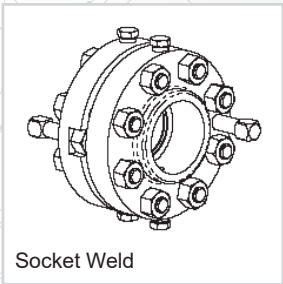
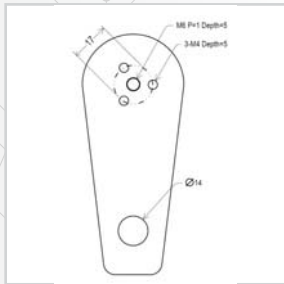
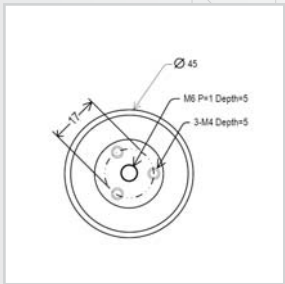
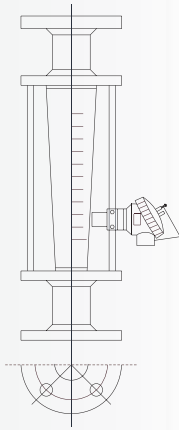
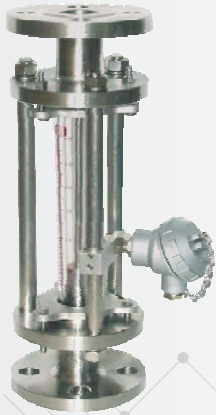

Socket Weld

Weld Neck



- Vibration Transmitter
- Control Valve
- Digital Meter
- Totalizer
- Programmer
- Hart Instruments Configurator
- Power Supply



## 展林企業股份有限公司

### 台北總公司

115603 台北市南港區園區街 3-1 號 5 樓之 3 (南軟二期G棟)

電話：02-27723316 傳真：02-81926485

E-mail：fayin.tw@msa.hinet.net

### 高雄辦事處

800408 高雄市新興區民生一路 56 號 21 樓之 6

電話：07-2266958 傳真：07-2135651

E-mail：fayin.tw@msa.hinet.net

## 上海展和測控技術有限公司

上海市楊浦區控江路1555號上海信息技術大廈A座2303室 郵編：200092

電話：021-58400551 傳真：021-58400521

E-mail：fayin.tw@msa.hinet.net

## FAYIN ENTERPRISE LIMITED

### Taipei Head Office

5F.-3, No. 3-1, Yuanqu St., Nangang Dist., Taipei City

115603, Taiwan, R.O.C. (NKSP II Building G)

TEL: 886-2-27723316

FAX: 886-2-81926485

E-mail：fayin.tw@msa.hinet.net

### Kaohsiung Branch Office

21F.-6, No. 56, Minsheng 1st Rd., Xinxing Dist.,

Kaohsiung City 800408, Taiwan, R.O.C.

TEL: 886-7-5549826

FAX: 886-7-2135651

E-mail：fayin.tw@msa.hinet.net

## TENWA MEASUREMENT & CONTROL CO., LTD.

Unit 2303, No.1555, Kongjiang Road, Yangpu District,

Shanghai, CHINA (Shanghai Information Technology Building A)

ZIP CODE: 200092

TEL: 86-21-58400551

FAX: 86-21-58400521

E-mail：shanghai@fayin.com.cn

